

Make IT Visible –
Advanced diagnostic
technologies moving
you forward

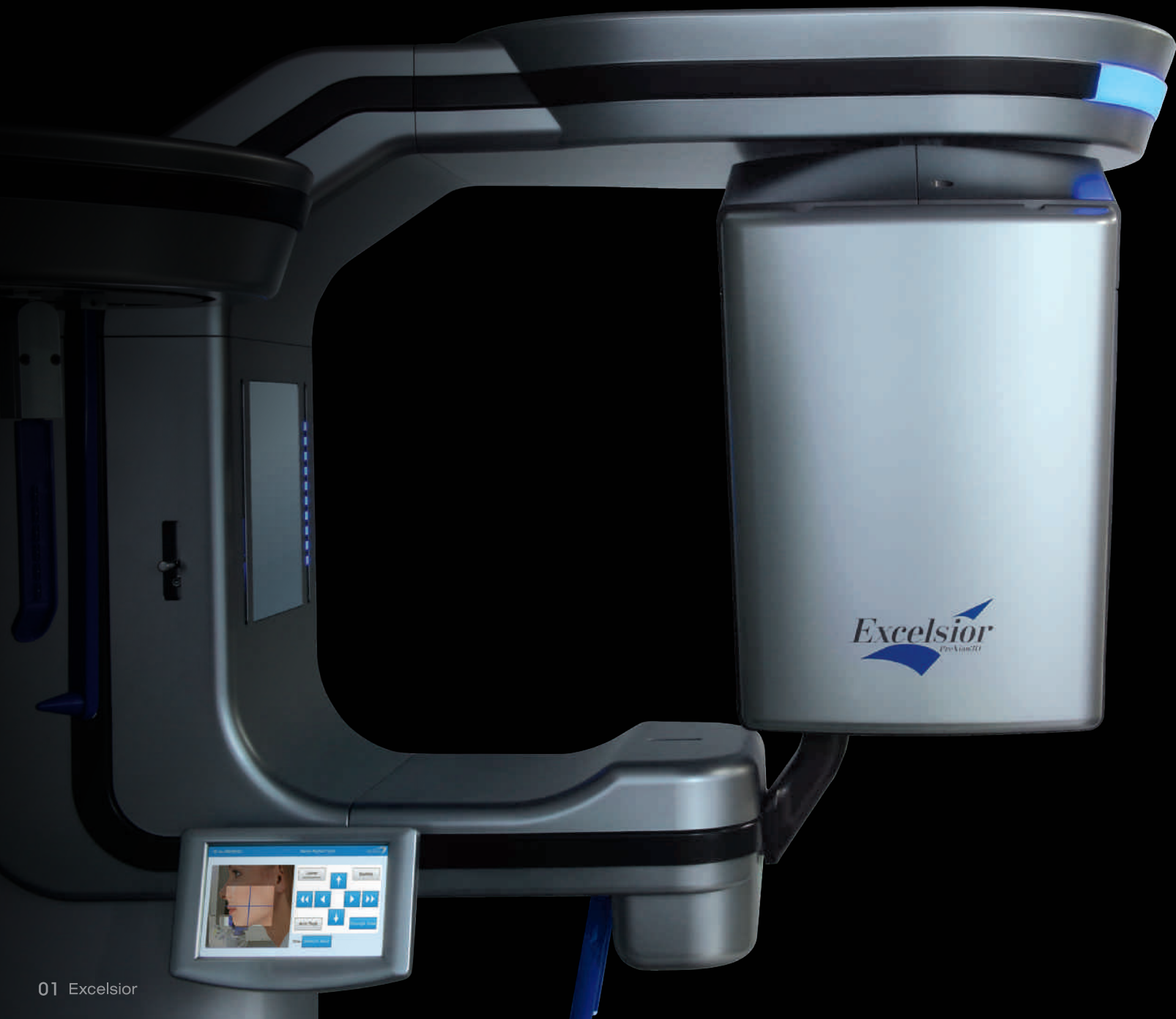

Quality Leader in Dental 3D CBCT Imaging



Make IT Visible – Meeting your challenges at every step.

We are committed to your success by focusing on low dose and advanced imaging technologies for accurate diagnosis and treatment. PreXion's legacy has always been founded on providing superior imaging quality with powerful and easy to use software. With over 15 years of experience in 3D DICOM image processing and software visualization, PreXion has distinct advantages over other CBCT scanners and is committed to "Make IT Visible" under every clinical circumstance.



Make IT Visible – Pioneers in innovation.

Improving image quality with exclusive innovative technologies

PreXion has improved the reliability and quality of all CBCT core technologies including the X-Ray Tube and the Flat Panel Detector (FPD) for both CT and Cephalometric. All done in-house, PreXion is supplying superior quality products from our state of art factory in Japan with excellence in quality assurance, production, and manufacturing flexibility.

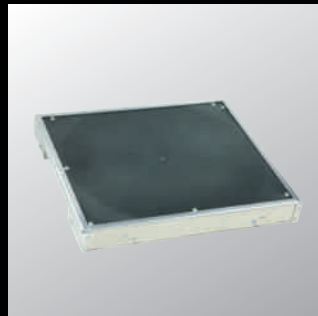

PreXion New FPD

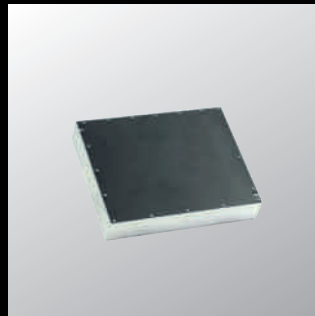

PreXion New Cephalo FPD

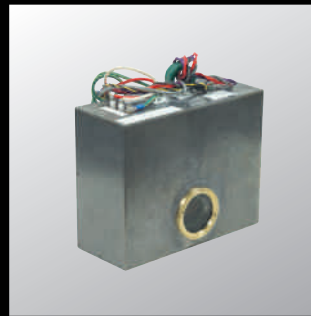

PreXion New X-Ray Tube



Imaging Quality

Our newly developed FPD, X-Ray Tube, and software – coupled with the world's smallest focal spot of 0.3mm – deliver industry leading image clarity with 6 times larger volume rendering for every clinical need.

Note: The Volume Rendering size is compared on following condition.
PreXion3D Excelsior: 1024 x 1024 x 816 voxel PreXion3D Eclipse: 512 x 512 x 512 voxel

Lower Dose

PreXion 3D Excelsior enables CBCT imaging with 30% lower patient radiation dose than current PreXion CBCT levels without any degradation in image quality.

Make IT Visible – See what you’ve been missing.

Increase your diagnostic and treatment accuracy with optimal FOV size

PreXion 3D Excelsior has 5 distinct FOV sizes ranging from 50x50mm, 100x50mm, 100x81mm, 150x81mm and 150x130mm, perfect to select for any clinical indication. Variation of imaging mode and the possibility to select the volume size according to your diagnosis allow you to obtain the highest image quality, all while by limiting radiation (in accordance with ALARA principles).

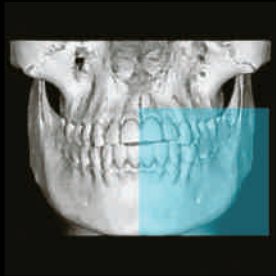

5 x 5

5x5 images work well for a specific area diagnosis with minimal X-ray exposure for the patient. It is especially effective for endodontic diagnosis by checking root canal conditions.



10 x 5

10x5 images generate a wide range to view oral conditions in the maxillary and mandibular areas. It is especially effective for clinical procedures related to the mandibular nerve, mental foramen, or maxillary sinus.



10 x 8

10x8 images generate comprehensive diagnosis and treatment planning. It is effective for complex implant surgery and diagnosis of the TMJ.

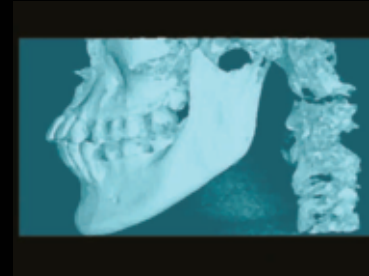

15 x 8

15x8 images generate the most optimal information for oral diagnosis covering both maxillary and mandibular structures in a single scan. It is effective for most oral surgery cases including placement of multiple implants.

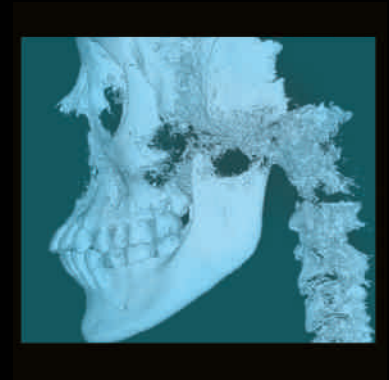

15 x 13

15x13 images generate the most optimal information of larger implant cases, airway and TMJ analysis, orthodontics and dental sleeping solutions. (Vertical Stitched)

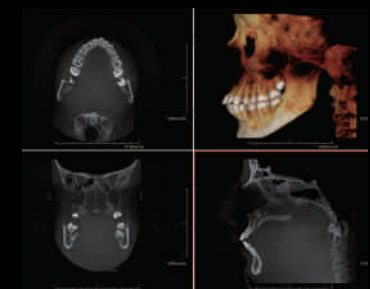
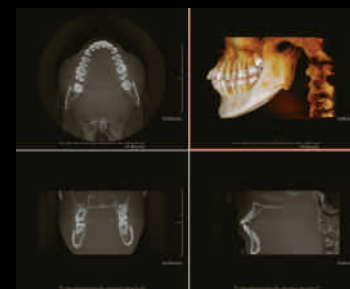
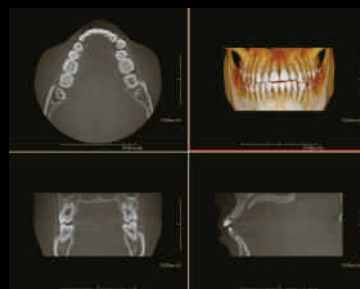

Make IT Visible – Versatility of selection.

PreXion 3D Excelsior provides several scan modes on the CT scan, Panoramic scan, Cephalometric exposure.

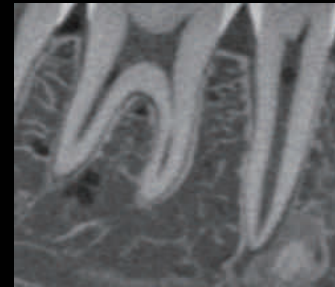
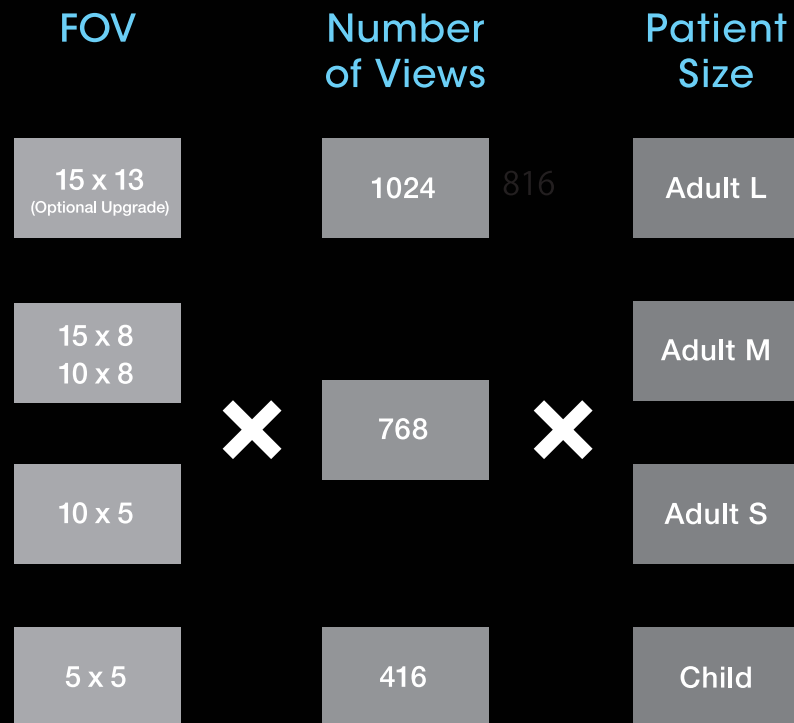

Ultra High Definition
512 volume mode

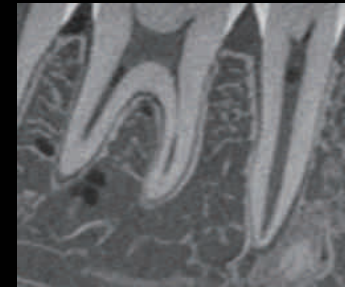

Ultra High Definition
1024 volume mode

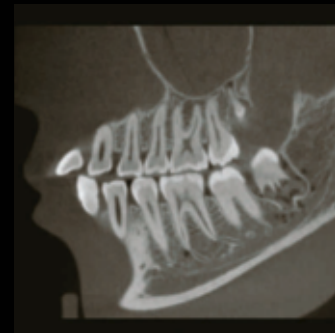

Standard mode
30% lower dose

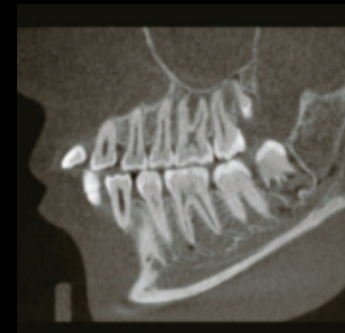

Rapid mode
70% lower dose

Note: The dose level is compared based on the following CT Scan mode condition:

	PreXion3D Excelsior	PreXion3D Eclipse
Scan Mode:	CT, Standard, Full Arch, Medium Adult	CT, High Definition
Scan Parameter:	110KV, 3.3mA, 12.8sec	90KV, 4mA, 8.7sec
FOV:	100mm x 81mm	81mm x 75mm
CTDIw:	2.9 mGy*	4.57 mGy*

*The dose measurements made using the methods described in Section 5.4 of IEC 61223-3-5:2004.

THE ADVANCED IMAGING QUALITY WITH NEW STANDARD OF PANORAMIC IMAGE

Panoramic

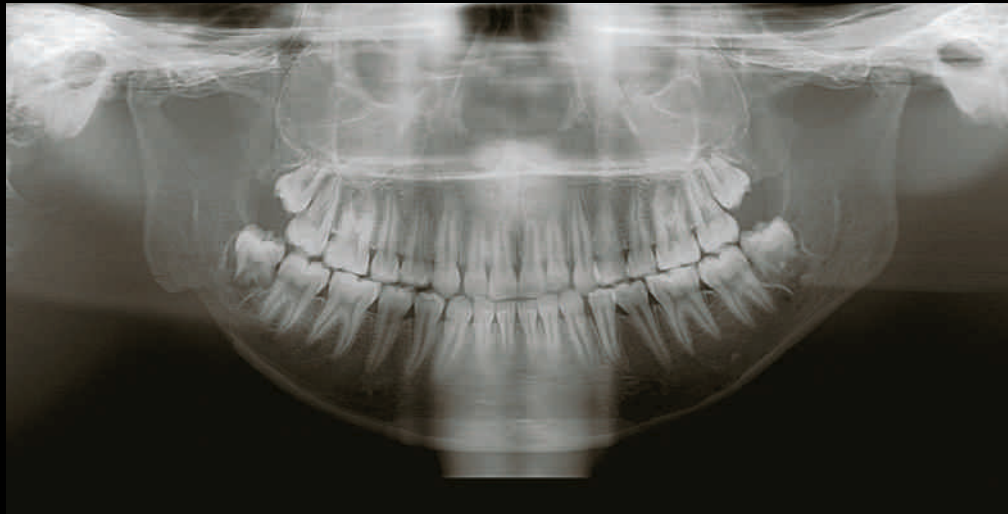

A clear and sharp panoramic image generates better diagnostics. Advanced details, especially in the anterior and dental roots can be easily viewed with PreXion 3D Excelsior. These consistently high quality panoramic images are the new standard of panoramic imaging solutions.

Bitewing

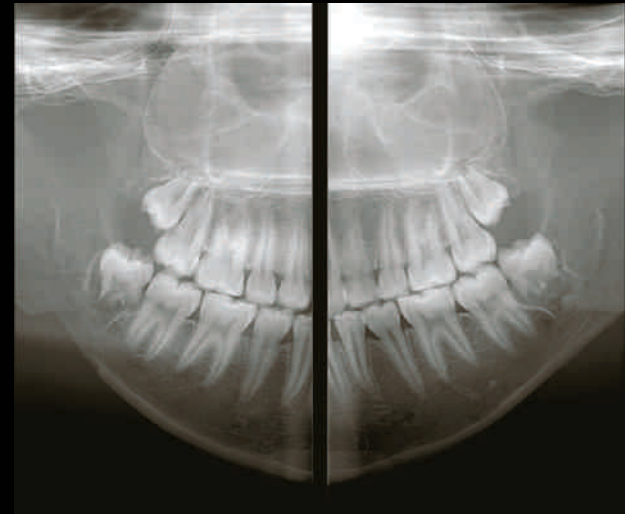

Manual Focus Function

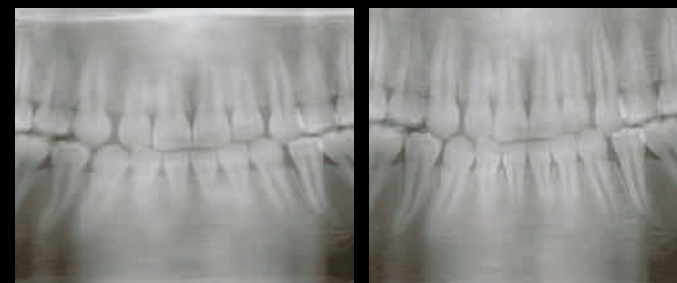

Make IT Visible – Capturing every specialty.

PreXion 3D Excelsior is designed to serve as an expandable platform to offer Cephalometric options for all your orthodontic needs. PreXion 3D Excelsior provides optimal images with an exclusively designed and developed FPD for cephalometric diagnosis. Our one-shot Cephalometric sensor delivers short exposure time with an incredibly low dose for the patient.



With Cephalometric sensor unit (Option)

Lateral

Lateral projection, Pediatric Lateral projection
30x25cm (12x10")



Posterior Anterior

Reverse towne projection,
Waters view

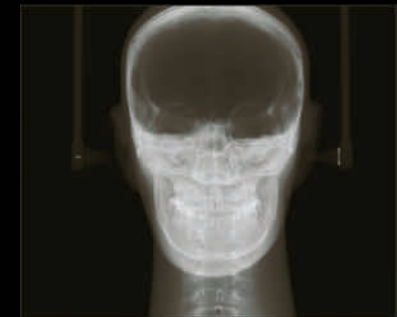

Carpus



Make IT Visible – Intuitive usability.

The large 7" touchscreen with an easy-to-use interface enables simple usage and set up. The user-friendly controls allow for quick, effortless, and intuitive workflow for all staff members for any clinical procedure.

Touch Screen Control Panel

Being able to directly and immediately position the patient has never been easier. The ability for the clinician to perfectly align the gantry for any patient regardless of height or size is quickly accomplished with a visual guide on the 7" touchscreen located directly beside the patient. Intuitive and efficient usability defined.

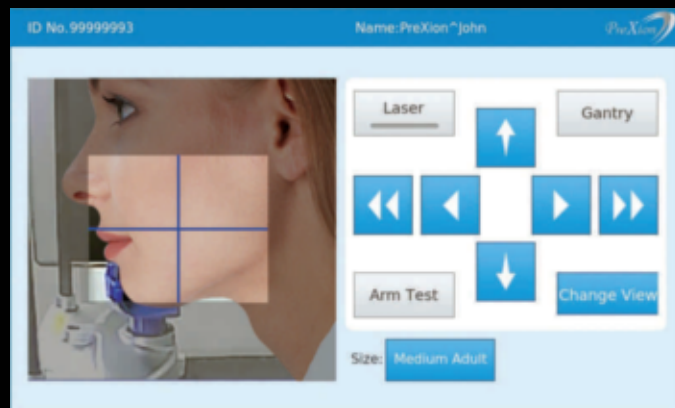

ORTHODONTICS

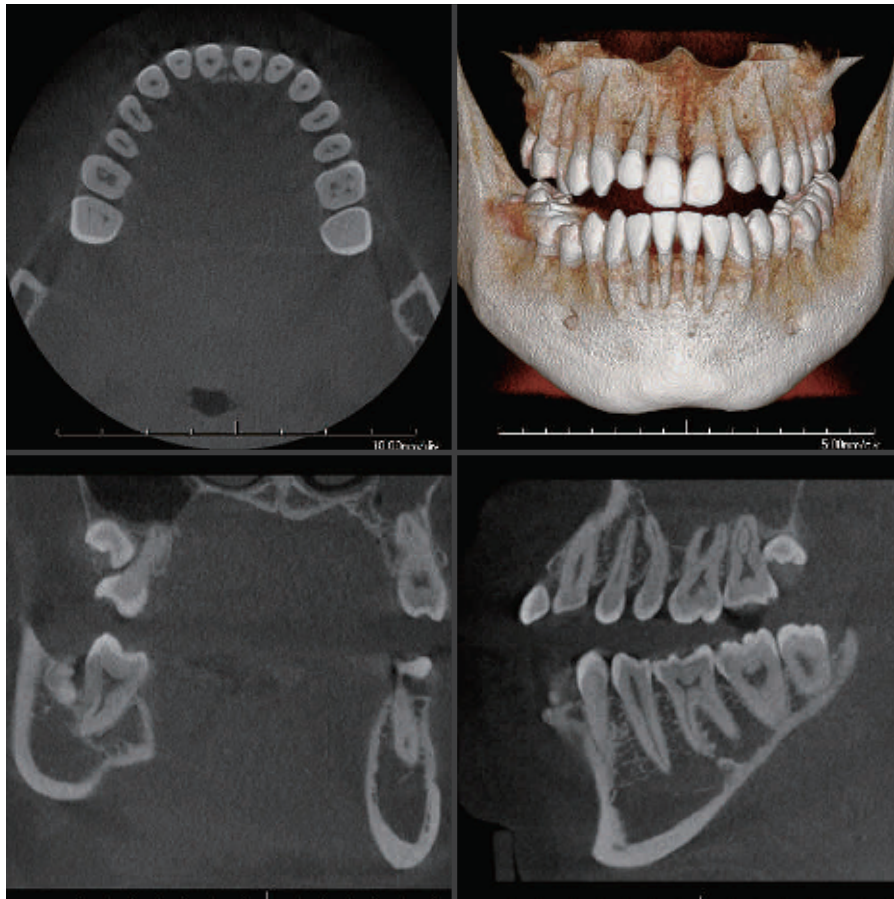

Optimize Treatment Plans with Greater Accuracy and Better Clinical Tools.

Proper orthodontic treatment starts with proper diagnosis. The PreXion Excelsior shows the exact relationship of all anatomy in stunning clarity for your treatment planning and case presentation. With our intuitive software, cephalometric tracing and measurements are fast and easy – further enhancing case planning with precision and accuracy. With the Excelsior's ultra-low dose mode, you can capture all the information you need with minimal radiation exposure, ensuring peace of mind for you and your patients.

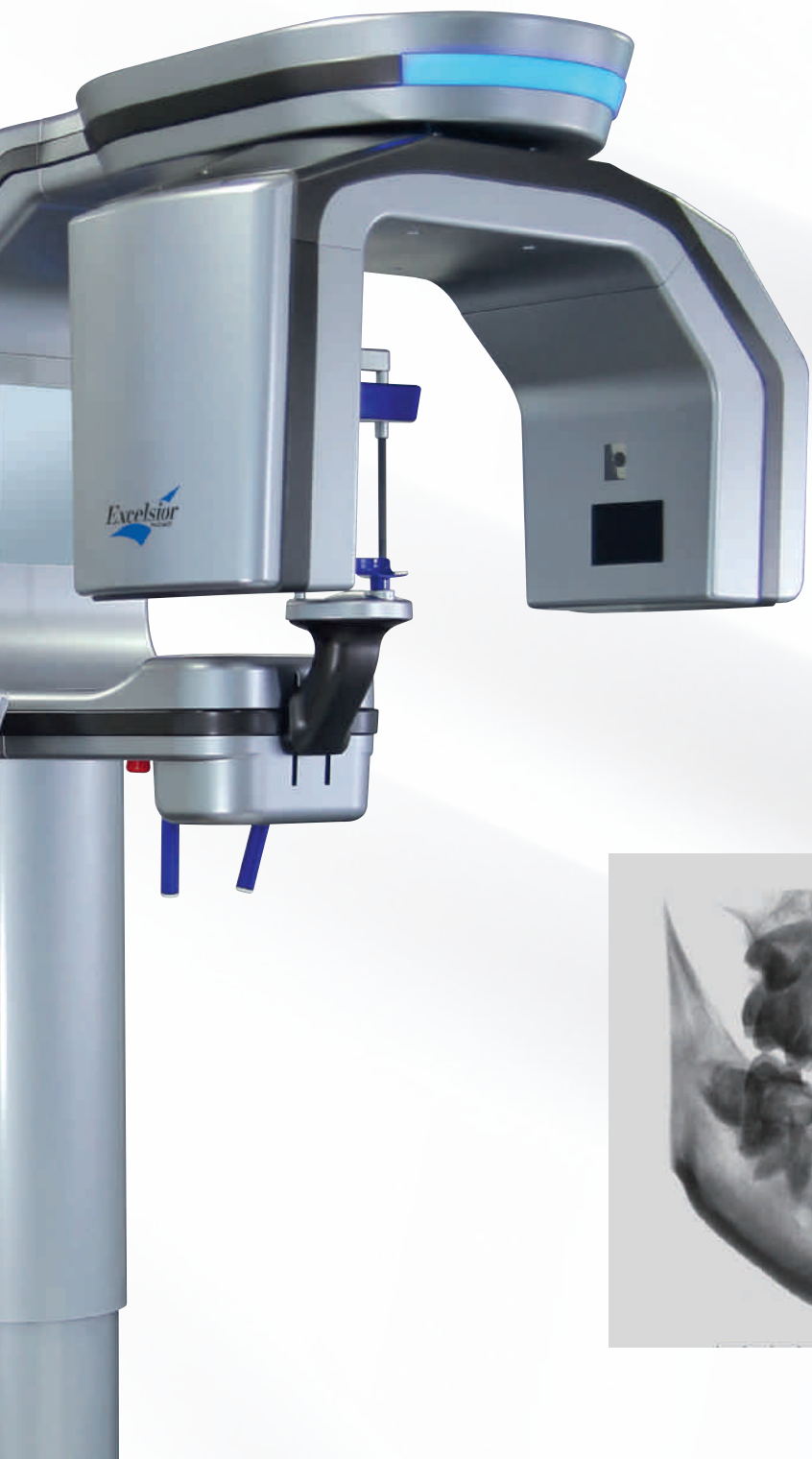

Jeffrey C. Miller, DDS Baltimore, MD

American Association of Orthodontists
American Dental Association
College of Diplomates of the American Board of
Orthodontics
Maryland State Dental Association
Mid-Atlantic Society of Orthodontists
Circle of Excellence 3M



"The ability to visualize the bone / root relationship is mission critical for our practice to better service our patients. The PreXion CBCT clearly shows the limitations of orthodontic tooth movement. I can't imagine practicing without it!"



IMPLANTS

Place and Restore with Accuracy and Confidence

The use of CBCT in implant dentistry is arguably the most common of all clinical applications. With the advancements in image quality found in the PreXion Excelsior, the highest levels of predictability and clinical success are at your fingertips. With our powerful implant planning software, you can easily and quickly map the mandibular nerve, assess bone quantity and quality, and determine the proper implant angulation and position. In addition, you now have the capability to export DICOM and STL data for further planning and surgical guide fabrication.

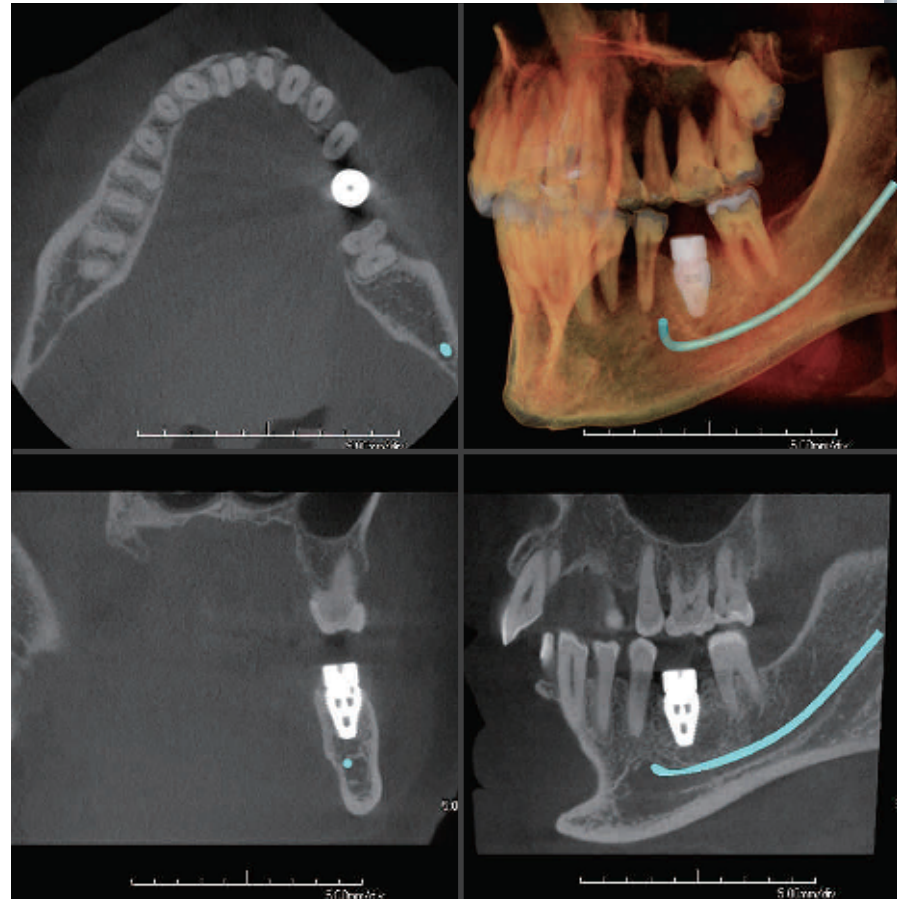

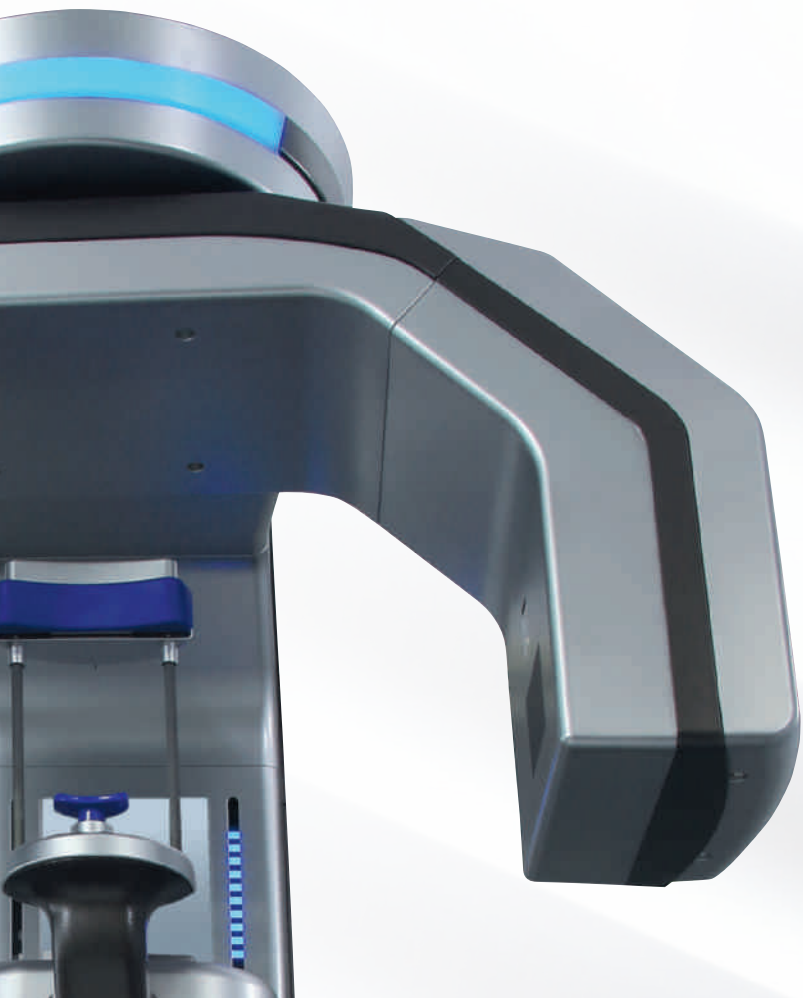

Dr. Bernee Dunson Atlanta, GA

Diplomate of the American Board of Oral
Implantology / Implant Dentistry Fellow in the
American Academy of Implant Dentistry Treasurer,
American Academy of Implant Dentistry



“With PreXion’s image quality, software capability, and customer support I can’t imagine anyone not using the PreXion CBCT who has an implant practice. The peace of mind and confidence this brings to every case – from the most simple to the most complex – is priceless.”

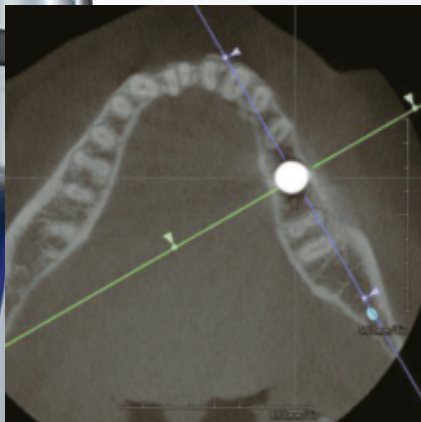

Post-op check (Axial)



Post-op check (3D)



Nerve canal check (3D)

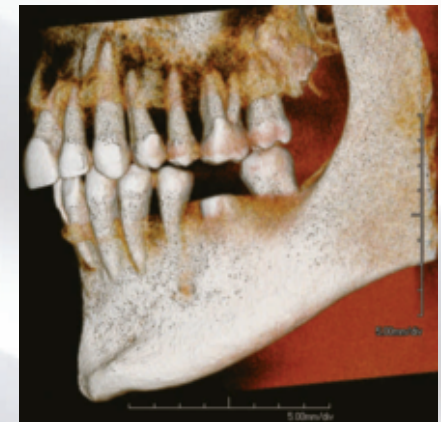

Surface check (3D)

ORAL SURGERY

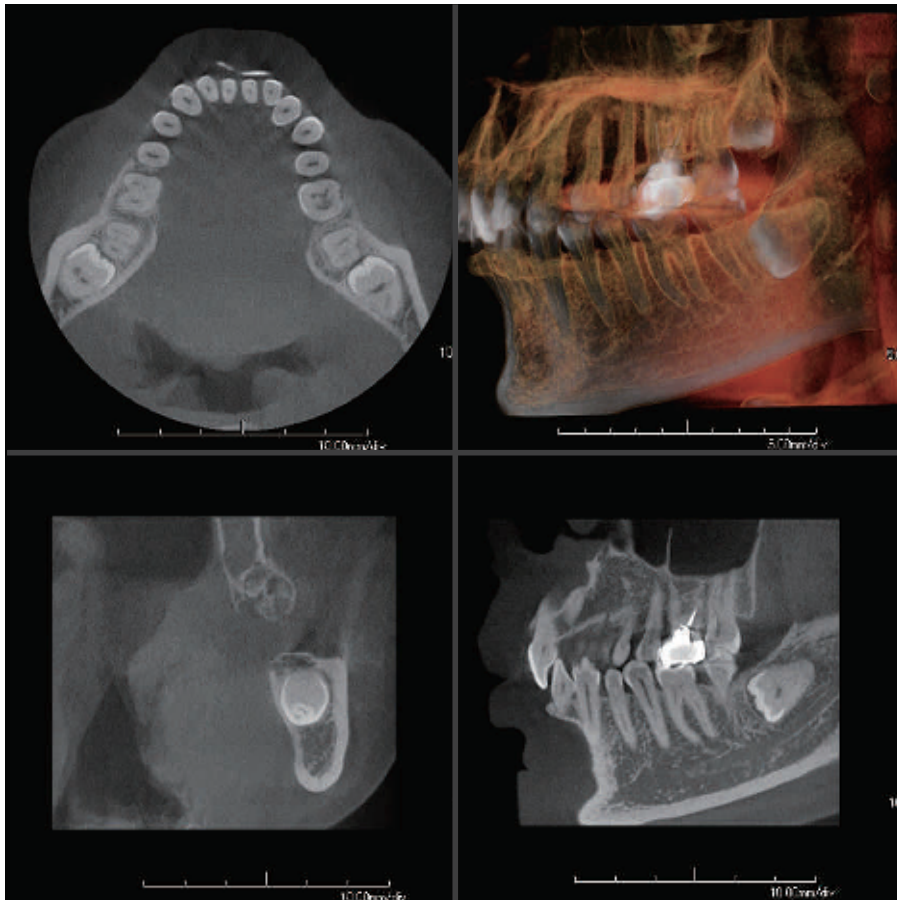

Map Surgical Treatment Plans

The ability to see what you previously have not been able to is invaluable to any practitioner who is either performing the surgery, or collaborating with a surgeon on a referral basis. Clearly see third molars, supernumerary teeth, and maxillary cuspids. Properly diagnose cysts, tumors, and lesions. Identify sinus walls, nerve positioning, and other vital structures and locations. The PreXion Excelsior will enhance outcomes and minimize complications.



Dr. Robert Walinchus Springfield, PA



President and Co-Director, Philadelphia Implant
Education Diplomate of the International Congress of
Oral Implantologists American Academy of Cosmetic
Dentistry American Academy of Dental Excellence
American Society of Hospital Dentists American
Association of Geriatric Dentists Academy of General
Dentistry American Dental Association

“With the PreXion CBCT, I now have the ability to comprehensively diagnose, plan, and treat every patient with confidence and accuracy. This technology directly impacts everything from sinus lifts, implant placement, bone grafting, surgical extractions, and more? this is absolutely the most valuable diagnostic tool in my practice.”

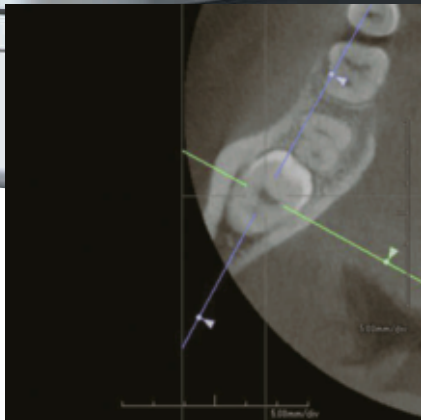

Axial view

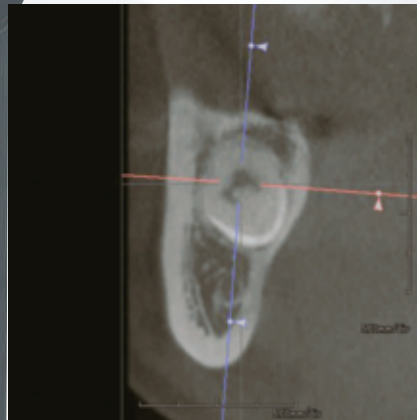

Coronal View

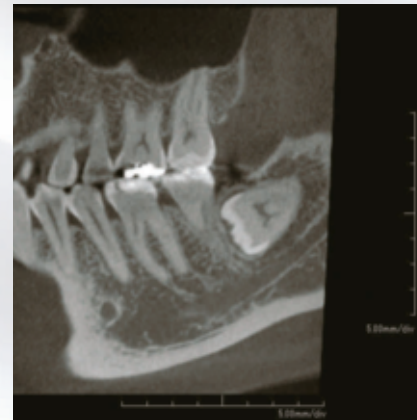

Sagittal View

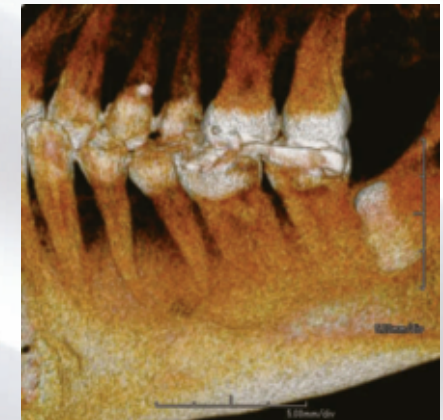

3D View

PERIODONTICS

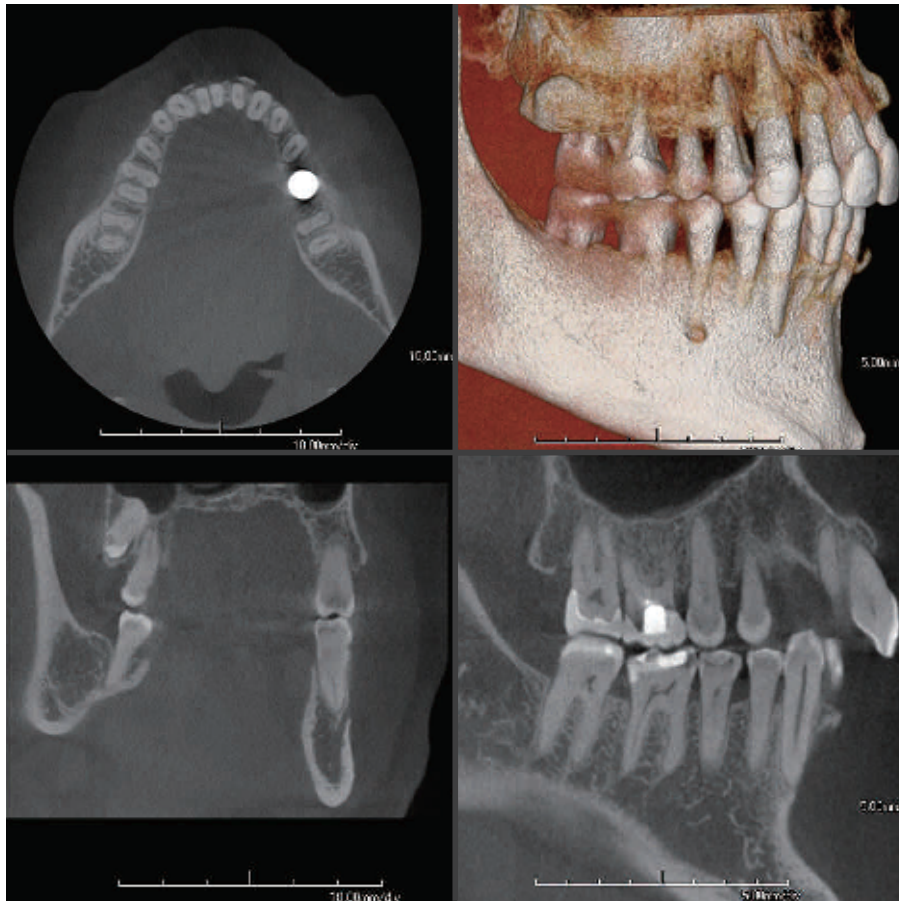

Clarity in Diagnosis and Treatment

The PreXion Excelsior has direct impact on all aspects of a progressive periodontal practice. From applications in implant planning and treatment, the ability to evaluate bone loss and defects, diagnose disease and pathology – there is not an area that the clarity of the Excelsior image cannot bring into focus and make visible.



Dr. Michael Morgan Periodontist, Cleveland, OH

American Academy of Periodontology
Academy of Osseointegration
American Dental Association
Ohio Dental Association
Greater Cleveland Dental Society

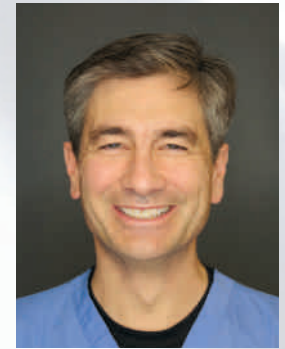

"My periodontal practice and patient care has elevated to higher levels with the integration of the PreXion CBCT. Anyone who thinks they can practice effectively and efficiently truly needs to discover what is possible. I would not want to practice without it!"



3D view

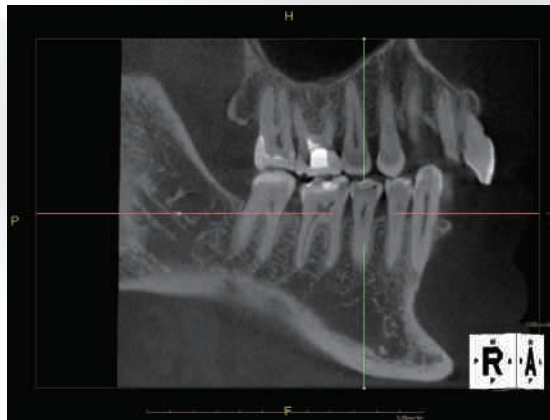

Sagittal View

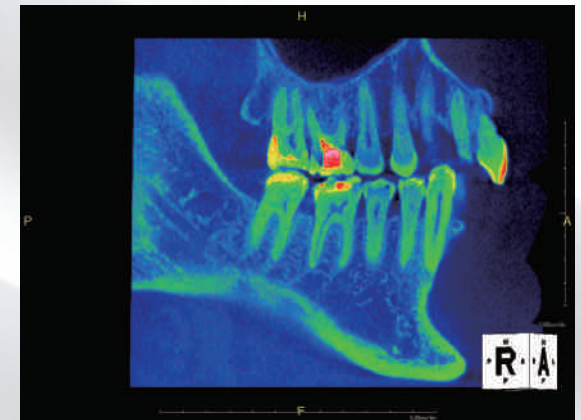

Color Template Mode

ENDODONTICS

See What You've Been Missing

The ability of the PreXion Excelsior to capture small areas with high resolution is one of the most powerful capabilities we can offer to endodontic diagnosis and treatment. The ability to identify an endodontic lesion and abscess and the capacity to see canals not visible in 2D are but a few of the capabilities unlocked with the Excelsior.

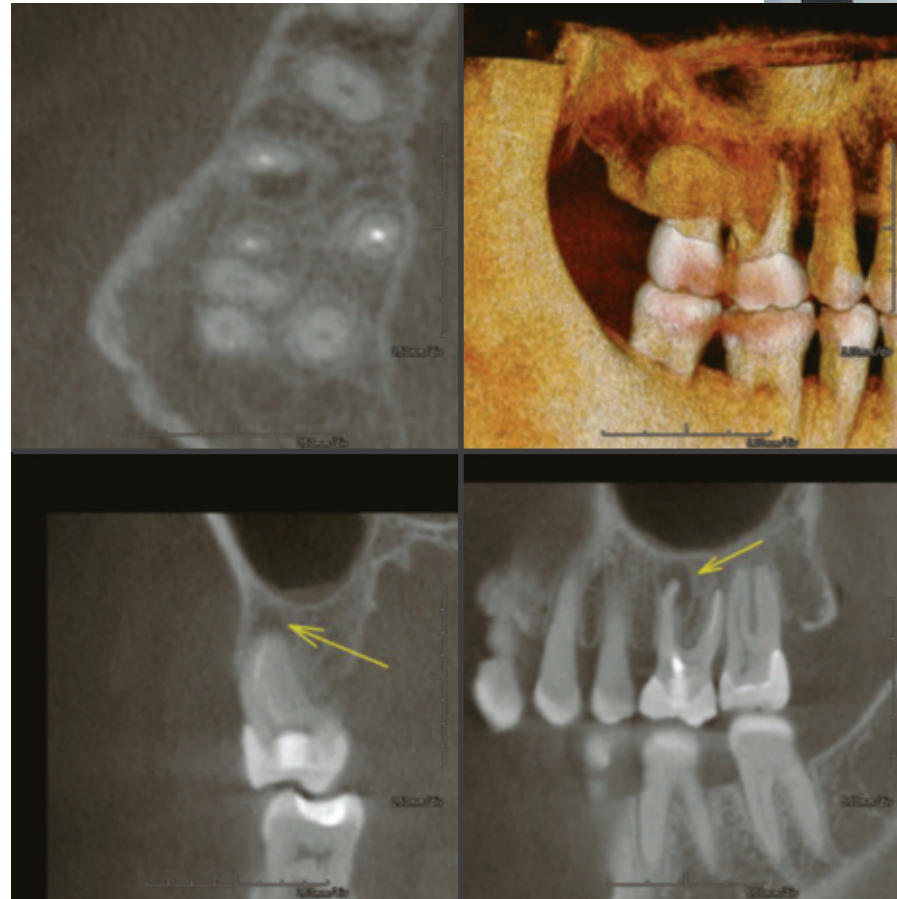

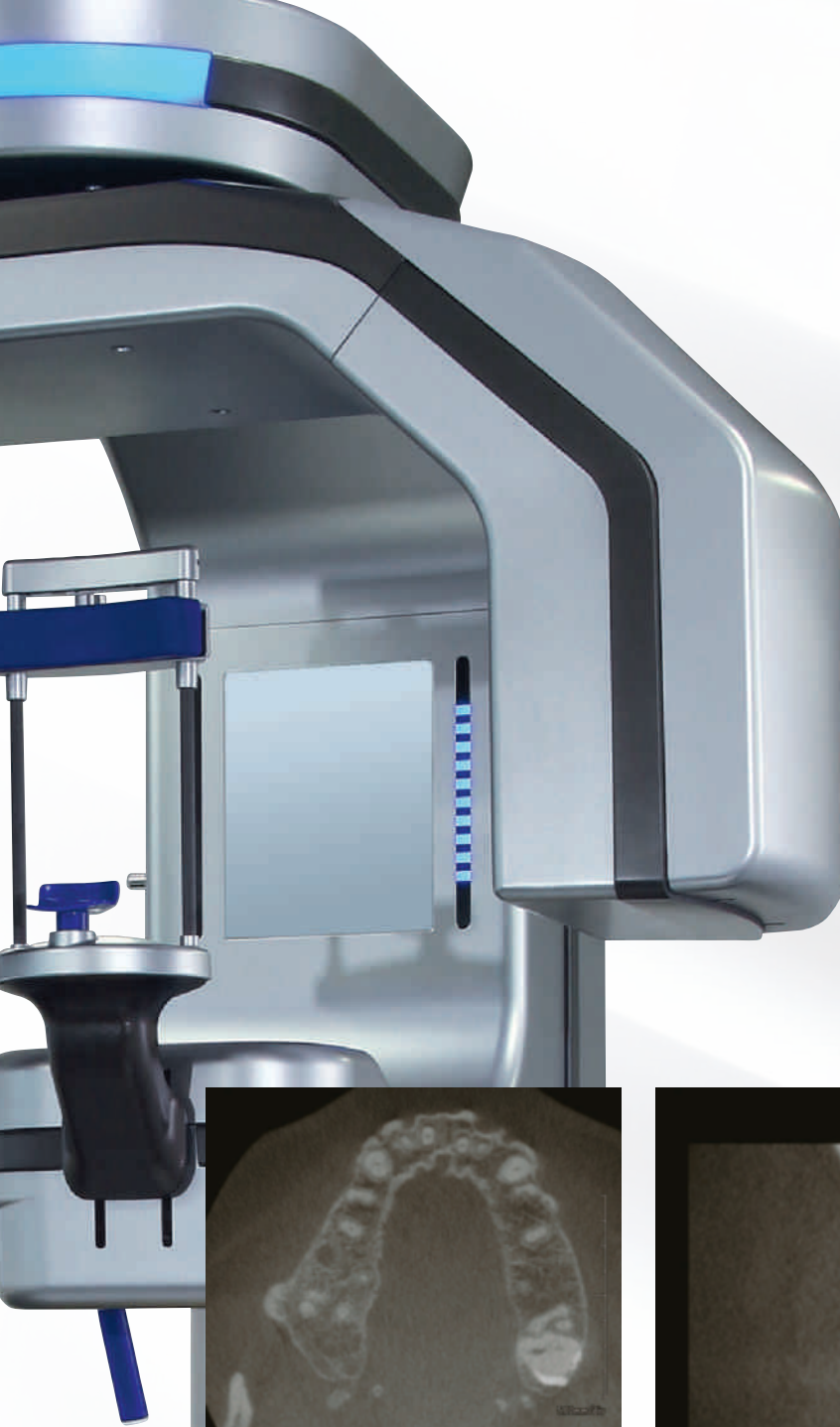

Dr. Le O'Leary Plano, TX

American Association of Endodontists
College of Diplomates of the American Board of Endodontics
American Dental Association
Texas Dental Association
Dallas County Dental Association
Southwest Society of Endodontists



"I have used CBCT in my endodontic practice for over a decade. When it came time for me to upgrade my system, I chose the PreXion CBCT. The PreXion image is the absolute best I've seen, and would encourage everyone to elevate their practice by incorporating this technology!"

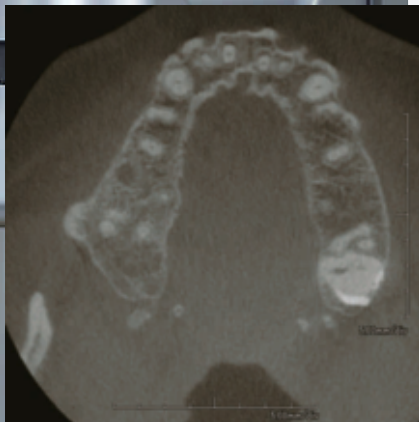

Axial view

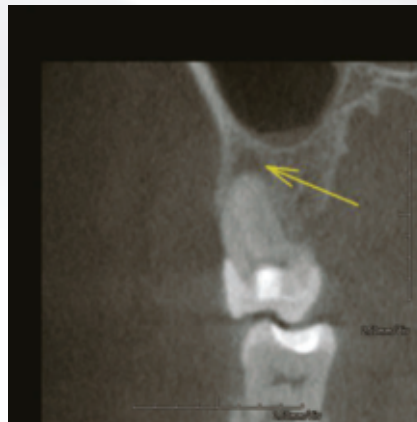

Coronal View



Sagittal View

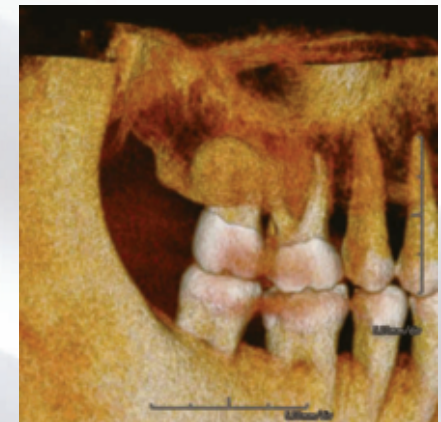

3D View

TMJ

Dr. Stephen Poss Brentwood, TN

Past Clinical Director Las Vegas Institute Fellow
Academy of Crainofacial Pain International Lecturer
on Esthetic Dentistry and TMD Diplomat in Sleep
Dentistry, Academy of Clinical Sleep Medicine
American Academy of Dental Sleep Medicine
American Academy of Sleep Medicine



“The ability to immediately capture all necessary TMJ information has been amazing for the way I practice and deliver patient care. PreXion has played a key role in my practice.”

TMJ Capture Mode – The Ability to Isolate

The PreXion Excelsior is able to aid in the assessment of the TMJ by showing condyle and fossa morphology in extremely clear detail. Diagnose and evaluate potential TMD issues including identifying erosions, osteophytes, and fractures. Accurately measure the volume and the surface of the condyle. With the PreXion Excelsior’s dedicated TMJ Scan mode, your patients are exposed to a fraction of the radiation.

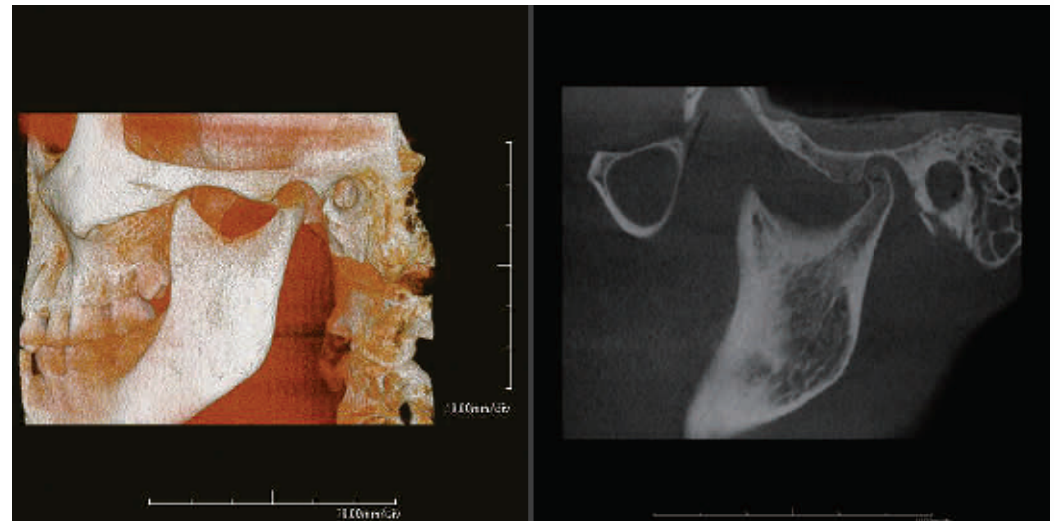

AIRWAY ANALYSIS

Dr. Jeff Horowitz Conway, SC

Carolina Center for Advanced Dentistry / Advanced Sleep and Breathing Centers Fellow, Academy of General Dentistry Mentor, Kois Center, Seattle WA Clinical Instructor, Catapult Education American Association of Dental Sleep Medicine American Academy of Cosmetic Dentistry American Equilibration Society American Academy of Craniofacial Pain American Orthodontic Society



"With its versatility and precision, our PreXion CBCT has revolutionized my approach to comprehensive patient care. From TMD to airway management and full mouth rehabilitation, PreXion has taken our practice to the next level."

Visualize and Discover New Treatments

With the PreXion Excelsior you can discover restricted airways, and see the pathway for optimal treatment for patients suffering from sleep disorders, sleep apnea, and sinus complications. Unlock the ability with our software to easily trace the airway, see restriction points, and calculate volume.

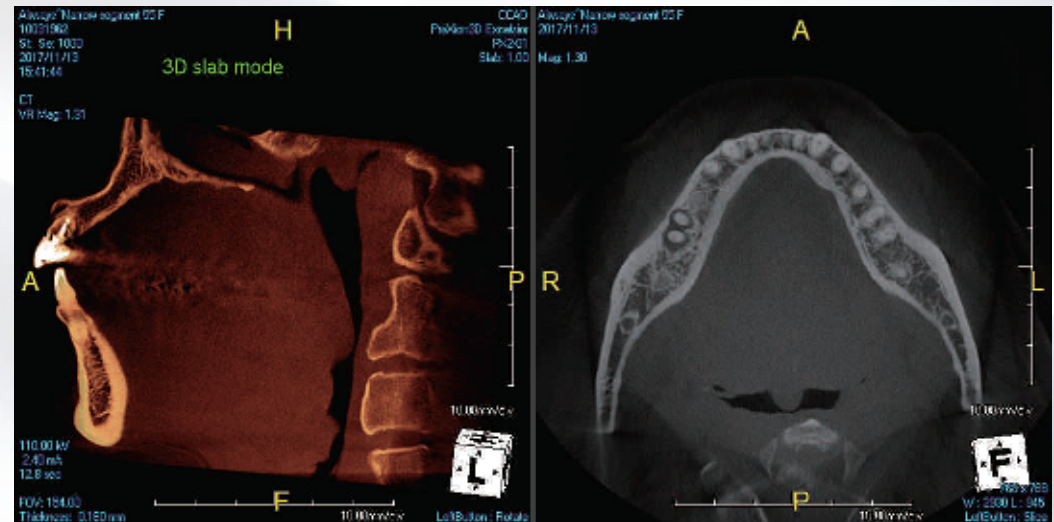

ENT

Defining Focus in Otolaryngology

In a position paper by The American Academy of Otolaryngology-Head and Neck Surgery (approved 4/13/2010 revised 9/28/2013) they stated that CBCT is an appropriate imaging modality of the paranasal sinuses, skull base, and temporal bones due to the fact that CBCT provides greater spatial resolution with significantly lower radiation levels than conventional CT (medical CT, MRI, or standard radiography).

The ability to provide point-of-care CBCT for diagnosis to otolaryngology patients has far-reaching and life altering benefits - immediate review of 3D images, a reduction in patient anxiety, immediate diagnosis, higher patient compliance, and reduced medical costs.

Every medical and dental specialty deserves the best. Treatment starts with diagnosis – now you can clearly see both health and disease of the sinonasal area, the temporal bone, maxillofacial trauma and abnormalities, and the inner ear with a fraction of the radiation with incredible image clarity. Make It Visible.

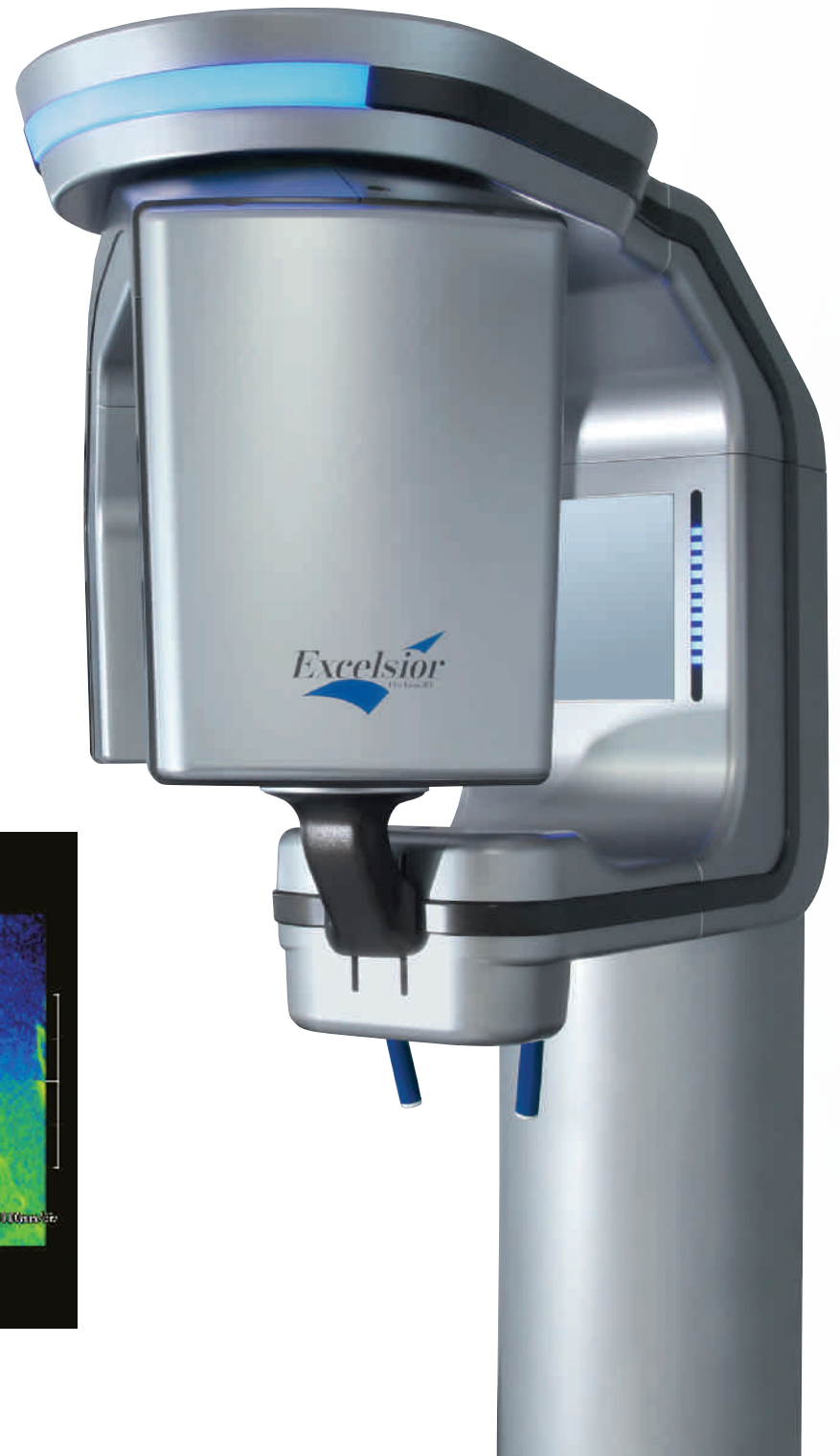
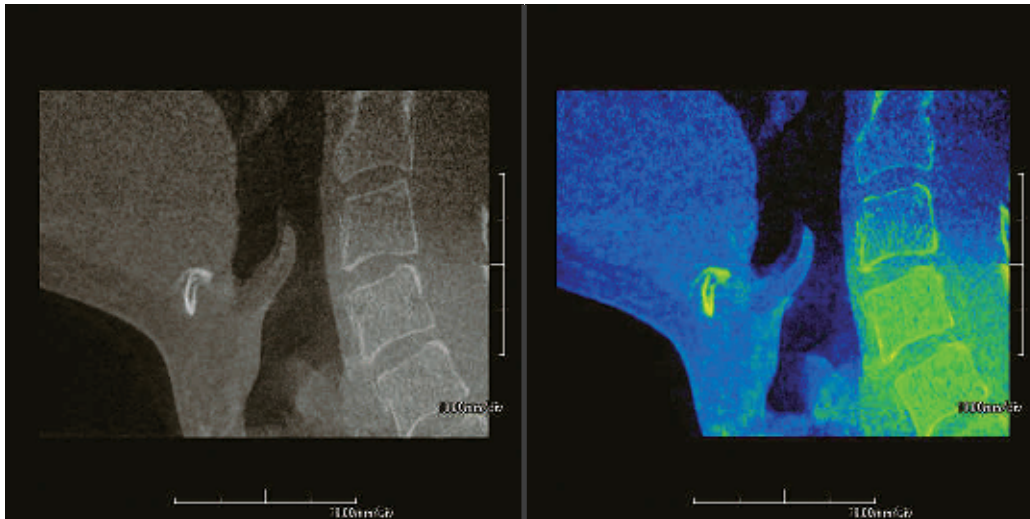



Make IT Visible – The Power of PreXion’s Concierge Service

PreXion is committed to excellence in service and support. A true industry leader understands that reputations are earned one customer at a time. PreXion has repeatedly provided a uniquely exceptional experience in the market for over 15 years with an uncompromising dedication to product reliability, service and support. From cutting-edge technology, industry-leading response times, and an expansive KOL support network, PreXion takes pride in delivering complete customer satisfaction.



**Christine Skordeles, DDS,
New York, NY**

"The PreXion CBCT I purchased was the best decision I've made. From the start, the entire PreXion team from front office to delivery and installation was a seamless experience. The clinical applications trainer Tony was great teaching how to use the scanner. Tech support is able to remote-in and assist in troubleshooting along with remote software updates. As a General Dentist, the PreXion CBCT increases Diagnostic capabilities to definitive diagnosis in root canals where it is a game changer, infections and critical diagnostic doctor decision making in our vast field of dentistry. The clarity, ease of use, and resolution of the scans make the PreXion CBCT and essential tool in state of the art dentistry and patient care. With the PreXion CBCT we can now see what the patient's chief complaint is in on the screen."

PreXion Concierge Service

1. Both online and in-office service and maintenance performed by our certified technicians.
2. Technology upgrade opportunities to meet expanding clinical offerings and demands.
3. Scholarship toward continuing education courses and seminars with PreXion Imaging Advisory Board doctors.
4. Additional in-office training and product consultations conducted by our professional and knowledgeable sales and training representatives.
5. Extended warranty.



With Cephalometric sensor unit

		Excelsior Pro	Excelsior Plus	Excelsior Ex
FOV	150 × 130 mm*	Optional upgrade	Optional upgrade	Optional upgrade
	150 × 81 mm	○	Optional upgrade	Optional upgrade
	100 × 81 mm	○	○	Optional upgrade
	100 × 50 mm	○	○	○
	50 × 50 mm	○	○	○
Volume size	1024 × 1024 × 1515	Optional upgrade	Optional upgrade	Optional upgrade
	1024 × 1024 × 816	○	○	Optional upgrade
	512 × 512 × 512	○	○	○
Cephalometric X-ray		Option	Option	Option

*Maximum FOV(150×130) is with vertical stitched.

FOV (Diameter by Height)	(Standard mode, High Definition(HD) mode, Ultra High Definition(UHD) mode) ø100 mm x H81 mm, ø100 mm x H50 mm, ø50 mm x H50 mm, ø150 mm x H81 mm			
	(Complete mode) ø150 mm x H130 mm			
	(Rapid mode) ø100 mm x H81 mm, ø100 mm x H50 mm, ø50 mm x H50 mm			
	(CT-TMJ mode) ø100 mm x H81 mm x 2			
	(CAD CAM mode) ø100 mm x H50 mm			
Scan Mode	(CT) Standard mode: 9.6sec, Rapid mode: 5.2sec(Half), High Definition(HD) mode: 12.8sec, Ultra High Definition(UHD) mode: 17.9sec, 23.6sec, Wide mode: 9.6sec, CT-TMJ mode: 5.2sec x 2, CAD CAM mode: 17.9sec			
	(Panoramics) Standard mode: 10sec, TMJ 2 mode: 4sec x 2, TMJ 4 mode: 4sec x 2 x 2			
	(Cephalometrics) LA mode: 0.5-0.8sec, PA mode: 0.5-0.8sec, Carpus mode: 0.5-0.8sec			
X-Ray	Focal Point	0.3 mm x 0.3 mm	FPD	(CT) FPD, 16bits (Cephalo) FPD, 14bits
	Tube Voltage	60 - 110kV	Voltage	100-120V, 50/60Hz Single Phase, 1.4kVA
	Tube Current	1 - 6.0mA	Patient Position	Standing/Wheel chair accessible

Dimensions

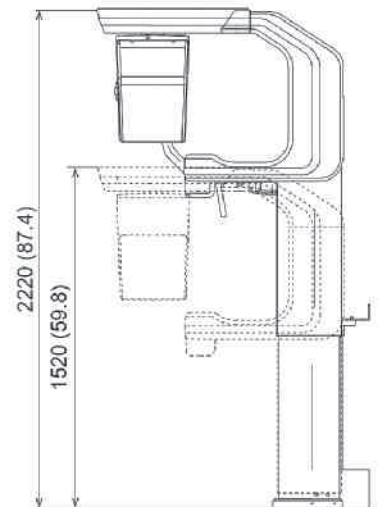
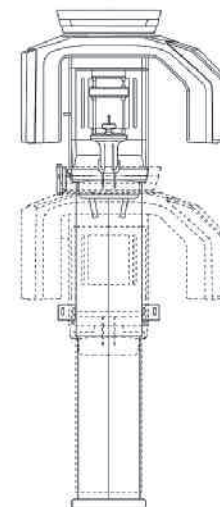
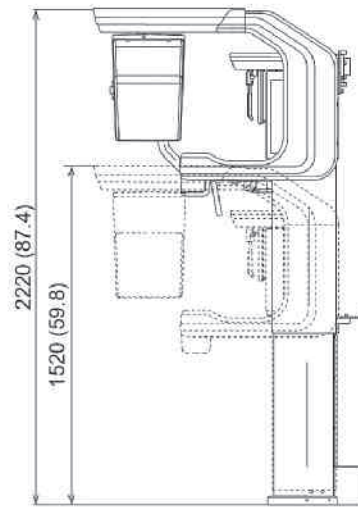
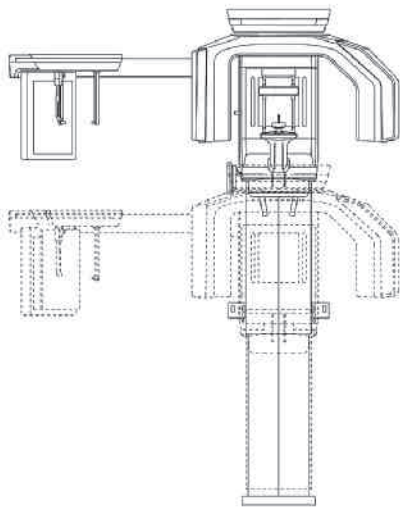
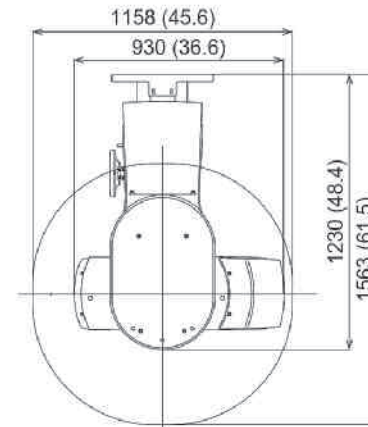
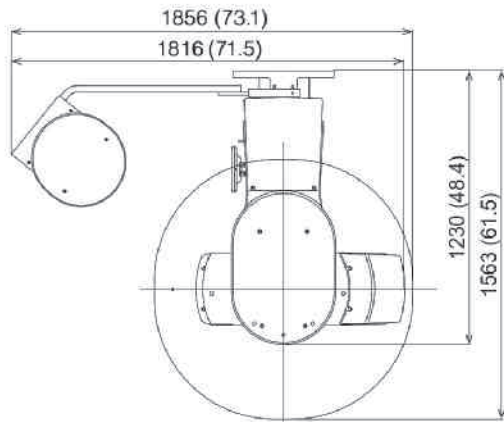

<With Cephalometric sensor unit>

<Without Cephalometric sensor unit>

IMAGING TECHNOLOGY MOVING YOU FORWARD



PreXion 3D Elite

2007



PreXion 3D Eclipse

2013



PreXion 3D Excelsior

2017

What we have done.



PreXion Corporation is a Japanese company specializing in medical imaging research and development. Since our company was founded in 2007 as a spin-off from TeraRecon, Inc. we have been developing and distributing primarily Dental Cone Beam CT in the US and globally. With our advanced accumulated imaging technologies, in 2015 we succeeded in developing the world's first technology of photoacoustic imaging system using NIR-LED as a light source. We are committed to continuously developing new technologies to contribute to human health throughout the world. We accomplish this through our company philosophy of "Make it Visible" coupled with our entrepreneurial spirit.

Who we are.



PreXion Corp
Tokyo, Japan

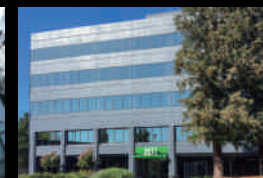

PreXion Inc.
San Jose CA USA



[USA]

PreXion, Inc.

2077 Gateway Place, Suite 120, San Jose, CA 95110, USA

Tel: +1-650-212-0300 Fax: +1-650-212-0310

E-mail : info@prexion.com <http://www.prexion.com>

[JAPAN]

PreXion Corporation

1-14-1 Kanda Suda-cho, Chiyoda-ku, Tokyo, 101-0041, Japan

Tel: +81-3-5297-2822 Fax: +81-3-5297-7552

E-mail : info@prexion.co.jp <http://www.prexion.co.jp>